

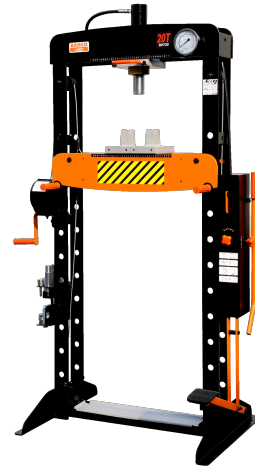

**BH720/BH730/BH750**  
**Prensa 20 T, 30 T y 50 T**



## DETALLES DEL PRODUCTO

- Prensa para taller de 20 T, 30 T y 50 T
- Diseño exclusivo de estructura robusta con formas redondeadas
- Medidor de presión grande relleno con glicerina para una fácil lectura a una altura cómoda de los ojos
- Bomba de doble velocidad con válvula de sobrecarga de seguridad integrada
- Pistón cromado duro deslizante
- Función de acercamiento rápido gracias al pedal o al agarrador
- Reglas para facilitar el centrado del pistón con el elemento que se va a extraer
- Dos bloques incluidos que se pueden utilizar en V o en plano en función de la necesidad
- Pasadores de centrado automático para la mesa
- Fácil elevación y descenso de la tabla de la prensa gracias al cabrestante con mango giratorio
- Pedal con panel de goma antideslizante
- Conjunto de punteros prensados con ocho pasadores y una placa perforadora incluida
- Agarradores aislados
- Bandeja para herramientas en la parte inferior
- Certificado CE de acuerdo con la normativa 2006/42/CE

**Follow the Fish!**



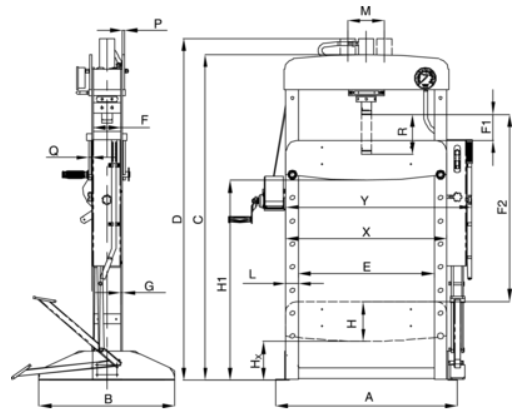

Smaller version of the technical drawing with a table of specifications below it.

Model	Motor	Power	Speed	Capacity	Weight	Dimensions (mm)	Dimensions (mm)	Dimensions (mm)	Dimensions (mm)	Dimensions (mm)	Dimensions (mm)	Dimensions (mm)	Dimensions (mm)	Dimensions (mm)	Dimensions (mm)
BH720	200W	1700	1700	100	100	1140	200	270	8	100	100	100	100	100	100
BH730	300W	1700	1700	100	100	1140	200	270	8	100	100	100	100	100	100
BH750	500W	1700	1700	100	100	1140	200	270	8	100	100	100	100	100	100
BH770	750W	1700	1700	100	100	1140	200	270	8	100	100	100	100	100	100

**BAHCO**  
www.anaeurope.com



Follow the Fish!





Contact: info@bahco.com / www.bahco.com

## ATRIBUTOS DE PRODUCTO



### Producto: **BH720**

	20.000 kg	<b>A</b>	880 mm	<b>B</b>	650 mm
<b>C</b>	1785 mm	<b>D</b>	1885 mm	<b>E</b>	645 mm
<b>F1</b>	43 mm	<b>F2</b>	1143 mm	<b>F</b>	129 mm
<b>G</b>	8 mm	<b>H</b>	165 mm	<b>L</b>	70 mm
<b>M</b>	211 mm	<b>X</b>	785 mm	<b>Y</b>	920 mm
	151 kg				

### Producto: **BH730**

	30.000 kg	<b>A</b>	960 mm	<b>B</b>	700 mm
<b>C</b>	1776 mm	<b>D</b>	1810 mm	<b>E</b>	695 mm
<b>F1</b>	140 mm	<b>F2</b>	1020 mm	<b>F</b>	137 mm
<b>G</b>	10 mm	<b>H</b>	200 mm	<b>L</b>	80 mm
<b>M</b>	195 mm	<b>X</b>	855 mm	<b>Y</b>	990 mm
	189 kg				

### Producto: **BH750**

	50.000 kg	<b>A</b>	1.000 mm	<b>B</b>	770 mm
<b>C</b>	1832 mm	<b>D</b>	1855 mm	<b>E</b>	725 mm
<b>F1</b>	173 mm	<b>F2</b>	1013 mm	<b>F</b>	204 mm
<b>G</b>	12 mm	<b>H</b>	243 mm	<b>L</b>	90 mm
<b>M</b>	280 mm	<b>X</b>	905 mm	<b>Y</b>	1070 mm
	309 kg				

